

NEW!



Labculture®
Labculture® • **RELIANT**

Model LA2-4A_-E.

NSF c UL US CFDA CE EN12469
NSF 49, UL 61010, JIS K3800, CFDA YY-0569, EN 12469

Class II, Type A2 and B2 Biological Safety Cabinets
The Most Certified Energy-Efficient, Safe, and Ergonomic
Biosafety Cabinet in the World

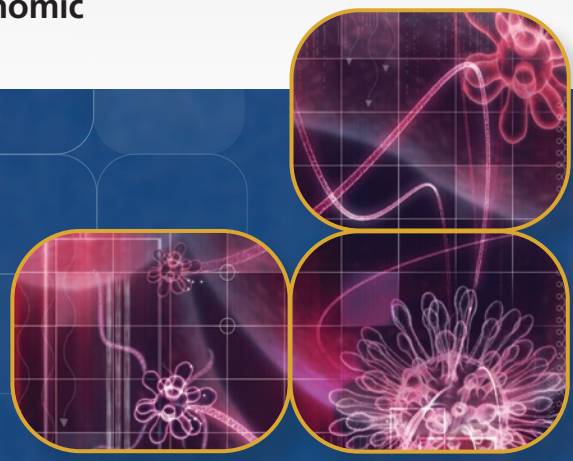

ESCO
SCIENTIFIC

LABCULTURE® CLASS II TYPE A2 (LA2) and B2 (LB2) BIOSAFETY

RS 232 SERIAL
INTERFACE PORT



Zero voltage
relay contact



RS 232 Port and Zero Volt Relay Contact

- RS 232 Port to send operational information to Building Management System (BMS)
- Zero Volt Relay Contact to turn ON/OFF exhaust blower and signal the building alarm

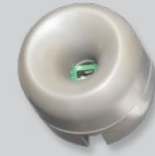

Airflow Sensor

- Monitors real-time airflow for safety
- Alert the user if airflow is insufficient

ESCO

Esco LA2 15:34
Exhaust: OK Sash: OK
I: 0.53 m/s D: 0.35 m/s
Socket: ON



Sentinel® GOLD
MICROPROCESSOR CONTROL SYSTEM

Sentinel™ Gold Microprocessor Controller

- Displays all safety information on one screen
- Centered and angled down for easy reach & viewing
- Selectable Quickstart mode for fast operation



Single Piece Wall

- Large radius for easy cleaning
- Side-mounted electrical outlets and staggered service fixtures, for easy reach



Single Piece Work Tray

- Recessed to contain spillage
- Curved grill to prevent blockage



Raised Arm Rest

- Helps prevent grille blocking
- Comfortable working posture



Angled Drain Pan

- Easy to clean
- Does not harbor contaminants

Available in 0.9, 1.2, 1.5, 1.8 and 2.4 meter models (3', 4', 5', 6' and 8'). Shown with optional telescoping stand.



NSF 49



UL 61010,



JIS K3800



CFDA YY-0569



EN 12469

Esco Labculture Class II Type A2 (LA2) has passed more performance tests in more languages, for more certifications throughout more countries than any other biological safety cabinet in the world.

Labculture® | Labculture® •RELIANT

LA2 & LR2 Class II Type A2 / LB2 Class II Type B2 Biological Safety Cabinets

CABINETS, FEATURING ADVANCED MICROPROCESSOR CONTROLLER



Pressure Switch (LB2 only)

- Temperature independent
- Fast response

Energy Efficient DC ECM Motor

- Powered by latest generation DC ECM motor, that is more efficient than legacy ECM and VFD motors
- 70% Energy savings compared to AC motor
- Stable airflow, despite building voltage fluctuations & filter loading
- Night Setback mode to further reduce power consumption by 60%

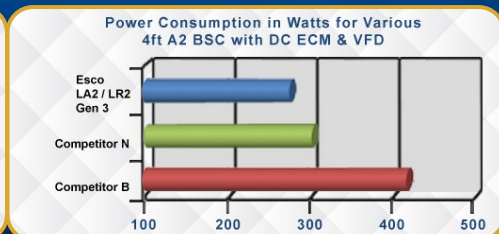
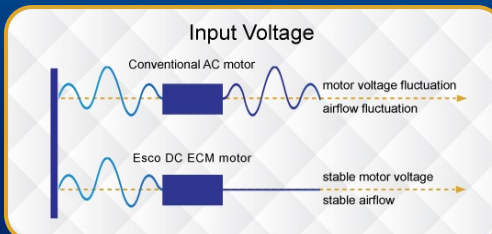

ULPA Filter

- 10x Filtration efficiency of HEPA filter
- Creates ISO Class 3 work zone instead of industry-standard ISO Class 5

Esco cabinets use ULPA filters (per IEST-RP-CC001.3) / H14 per EN 1822 instead of H13 HEPA filters used on many BSCs in the market.

HEPA filters only offer 99.99% typical efficiency at 0.3 micron, while ULPA filters provide 99.999% typical efficiency for particle sizes of 0.1 to 0.3 micron.

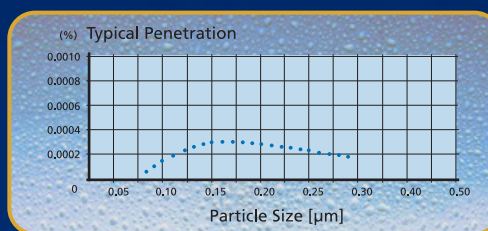

Dynamic Chamber

- Blower plenum and side walls are surrounded by negative pressure
- Prevent contaminants from escaping outside

- Positive pressure
- Negative pressure

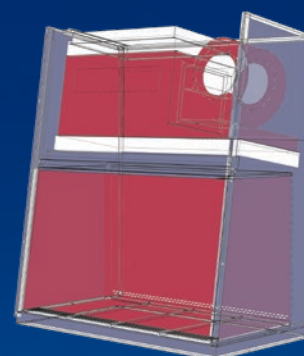

ISOCIDE™ powder coat

- Silver-ion impregnated powder coat
- Inhibit microbial growth to improve safety

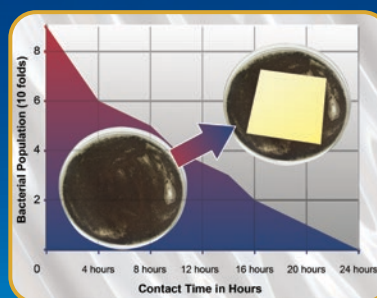

The Most Certified BSC in the World

Standards Compliance	Biosafety Cabinets	Air Quality	Filtration	Electrical Safety
	NSF / ANSI 49, USA* EN 12469, Europe** JIS K 3800, Japan** CFDA YY-0569, China	ISO 14644.1, Class 3, Worldwide JIS B9920, Class 3, Japan BS5295, Class 3, UK US Fed Std 209E, Class 1 USA	EN-1822 (H14), Europe IEST-RP-CC001.3, USA IEST-RP-CC007, USA IEST-RP-CC034.1, USA	UL-C-61010A-1, USA CSA22.2, No.1010-192, Canada EN-61010-1, Europe IEC61010-1, Worldwide

*The NSF / ANSI 49 certified models are: LA2-4A1-E, LA2-4A2-E, LA2-4A3-E, LA2-5A1-E, LA2-5A2-E, LA2-5A3-E, LA2-6A1-E, LA2-6A2-E, LA2-6A3-E, LB2-4B1-E, LB2-4B2-E, LB2-4B3-E, LB2-5B1-E, LB2-5B2-E, LB2-5B3-E, LB2-6B1-E, LB2-6B2-E and LB2-6B3-E.

Note: LA2 cabinets are certified to NSF, EN, JIS, and CFDA. LB2 cabinets are certified to NSF and CFDA.

**EN 12469 and JIS K 3800 are applicable in LA2 model only.



Rocker Switches and Pressure Gauge

- Easy to use switches
- Displays filter loading status
- Manually adjustable UV timer

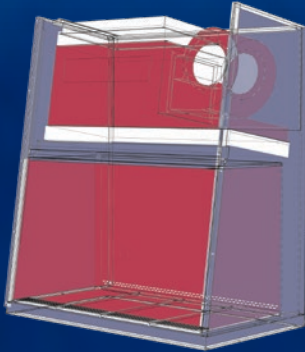

Dynamic Chamber

- Blower plenum and side walls are surrounded by negative pressure
- Prevent contaminants from escaping outside

- Positive pressure
- Negative pressure



Single Piece Wall

- Large radius for easy cleaning
- Side-mounted electrical outlets and staggered service fixtures, for easy reach

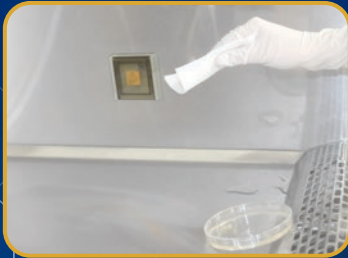

Single Piece Work Tray

- Recessed to contain spillage
- Curved grill to prevent blockage



Raised Arm Rest

- Helps prevent grille blocking
- Comfortable working posture



Angled Drain Pan

- Easy to clean
- Does not harbor contaminants



Available in 0.9, 1.2, 1.5, 1.8 and 2.4 meter models (3', 4', 5', 6' and 8'). Shown with optional telescoping stand.



NSF 49



UL 61010,

CABINETS, FEATURING ADVANCED MICROPROCESSOR CONTROLLER



Energy Efficient DC ECM Motor

- Powered by latest generation DC ECM motor, that is more efficient than legacy ECM and VFD motors
- 70% Energy savings compared to AC motor
- Stable airflow, despite building voltage fluctuations & filter loading
- Night Setback mode to further reduce power consumption by 60%

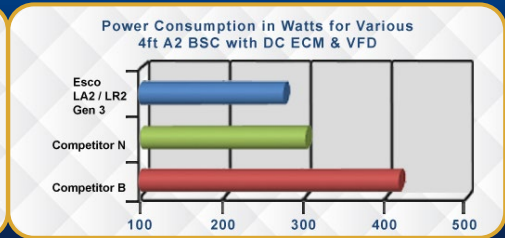
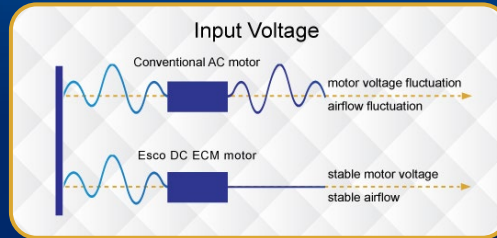

ULPA Filter

- 10x Filtration efficiency of HEPA filter
- Creates ISO Class 3 work zone instead of industry-standard ISO Class 5

Esco cabinets use ULPA filters (per IEST-RP-CC001.3) / H14 per EN 1822 instead of H13 HEPA filters used on many BSCs in the market.

HEPA filters only offer 99.99% typical efficiency at 0.3 micron, while ULPA filters provide 99.999% typical efficiency for particle sizes of 0.1 to 0.3 micron.

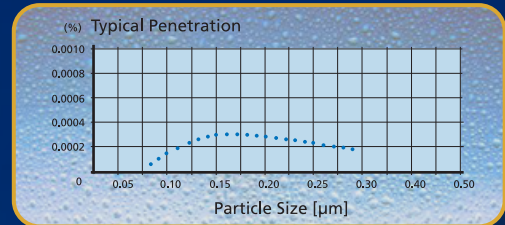

Adjustable UV Timer

- Easily adjustable to desired minutes or hours
- Prolongs UV lamp, for not turning it ON overnight



ISOCIDE™ powder coat

- Silver-ion impregnated powder coat
- Inhibit microbial growth to improve safety

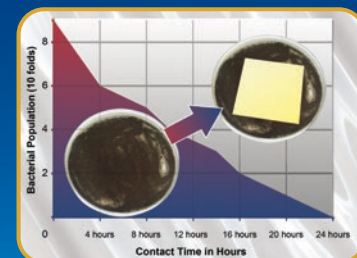

Certification

	Biosafety Cabinets	Air Quality	Filtration	Electrical Safety
Standards Compliance	NSF / ANSI 49 NSF	ISO 14644.1, Class 3, Worldwide JIS B9920, Class 3, Japan BS5295, Class 3, UK US Fed Std 209E, Class 1 USA	EN-1822 (H14), Europe IEST-RP-CC001.3, USA IEST-RP-CC007, USA IEST-RP-CC034.1, USA	UL-C-61010A-1, USA CSA22.2, No.1010-192, Canada EN-61010-1, Europe IEC61010-1, Worldwide

*The NSF / ANSI 49 certified models are: LR2-4S1-E, LR2-4S2-E, LR2-4S3-E, LR2-5S1-E, LR2-5S2-E, LR2-5S3-E, LR2-6S1-E, LR2-6S2-E, and LR2-6S3-E.

LA2 and LR2 CLASS II TYPE A2 BIOSAFETY CABINETS



Cabinet Filtration System

- Ambient air is pulled through front grille to create inflow, without going into the work surface. Inflow is joined by half of the downflow, to create front air curtain that is fine-tuned to create a large performance envelope. The combined air stream travels through the back air column towards the blower.
- Approximately 1/3 of the air in the common plenum is exhausted through the ULPA filter to the room. The remaining 2/3 of the air is passed through the downflow ULPA filter and into the work area as a vertical laminar flow air to create ISO Class 3 work surface and prevents cross contamination.
- Near the work surface, the downflow splits. About half goes to the front grille, and half goes to the rear grille. A small portion enters the side capture zones to prevent dead air corners (small blue arrows).
- The design was optimized to give large performance envelope, that provides operator and product protection at wide Inflow and Downflow variation from the Nominal point.

The Performance Envelope Concept

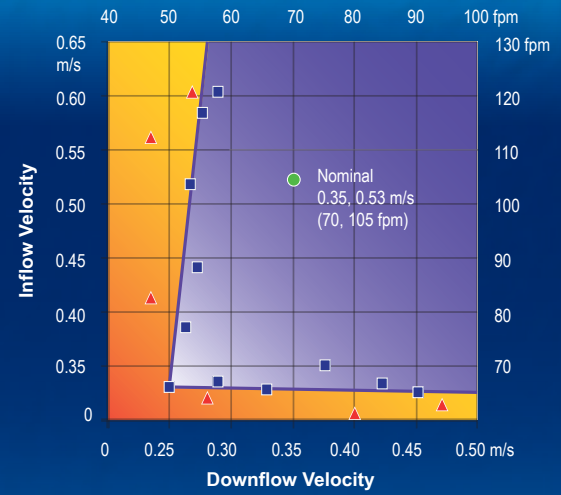

- Nominal Airflow
- Personnel / Product Protection
- Area of Personnel / Product Protection
- ▲ No Personnel / Product Protection
- Area of no Personnel / Product Protection

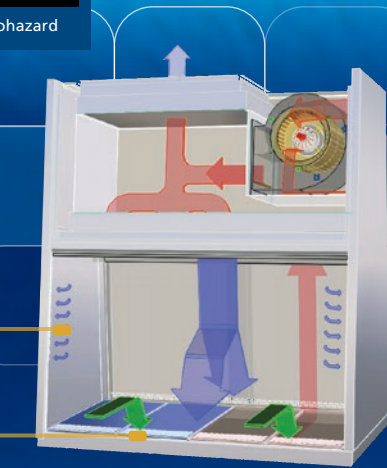

Dynamic air barrier, where inflow and downflow converge

Side capture zones

- ULPA-filtered air
- Unfiltered / potentially contaminated air
- Room air / Inflow air

Model LA2 and LR2 Biological Safety Cabinet Engineering Drawing

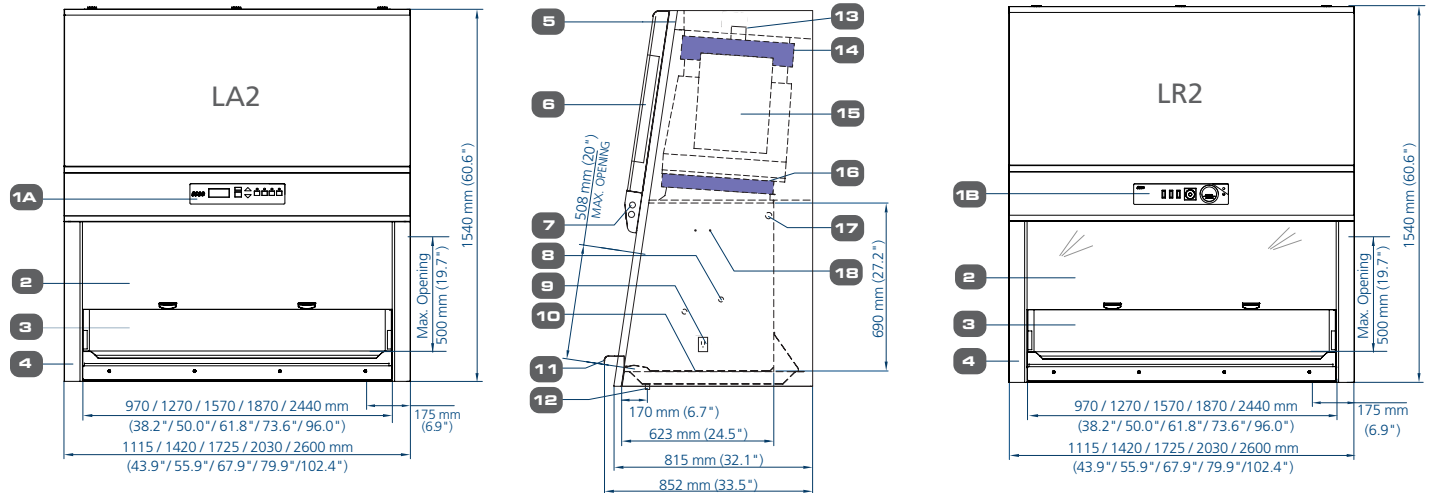

- 1A. (LA2 and LB2) Sentinel™ Gold Microprocessor Controller
- 1B. (LR2) Simple Switches Controller
- 2. Tempered Glass Sash Window
- 3. Stainless Steel Back Wall
- 4. Side Panel
- 5. RS232 Port, Zero Volt Relay Contact
- 6. Electrical Panel

- 7. Fluorescent Lamp
- 8. Service Fixture Retrofit Kit Provision (2 on each side)
- 9. Electrical Outlet Retrofit Kit Provision
- 10. Stainless Steel Single Piece Work Tray
- 11. Arm Rest
- 12. Drain Valve

- 13. Airflow Sensor
- 14. Exhaust H14 Filter
- 15. Energy-efficient DC ECM Blower
- 16. Downflow H14 Filter
- 17. UV Light Retrofit Kit Provision
- 18. IV Bar Retrofit Kit Provision

Optional Exhaust Collar Positions for Thimble-Ducting for LA2 and LR2 Models

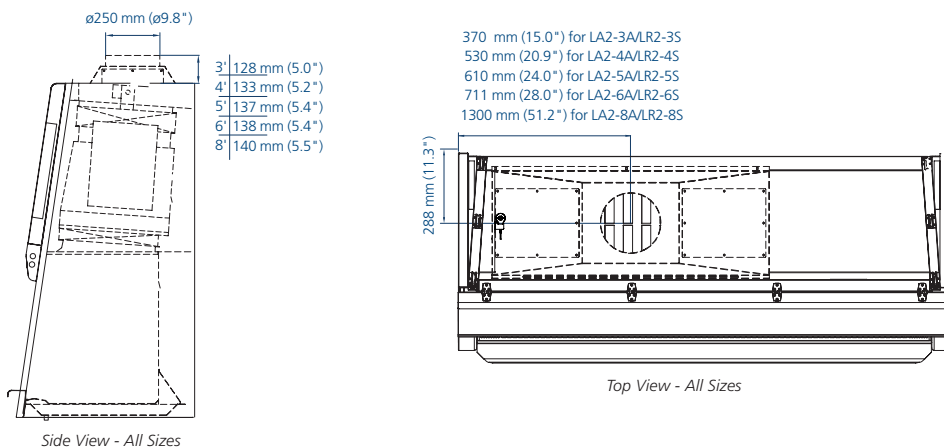



LB2 CLASS II TYPE B2 BIOSAFETY CABINET

For Biohazard and Chemical Hazard

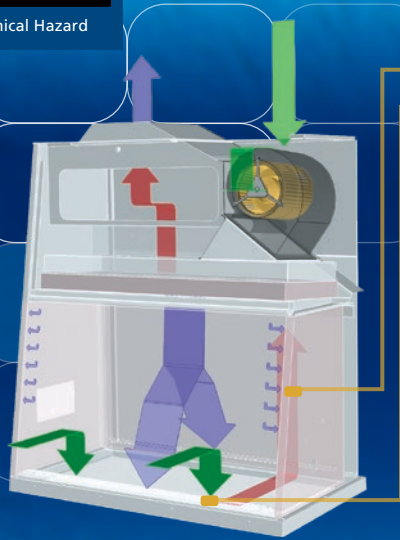

- ULPA-filtered air
- Unfiltered / potentially contaminated air
- Room air / Inflow air

Cabinet Filtration System

Side capture zones

Dynamic air barrier, inflow and forward-directed downflow air converge

- Ambient air is pulled through the front grille to prevent contamination of the work surface and work product. The inflow does not mix with the clean air within the cabinet work zone.
- Ambient air is taken in through a pre-filter at the top of the cabinet, and passes through the downflow ULPA filter, entering the work zone as laminar flow. The uniform, non-turbulent air stream protects against cross contamination within and throughout the work area.
- Near the work surface, the downflow air stream splits with a portion moving toward the front air grille, and the remainder moving to the rear air grille. A small portion of the ULPA filtered downflow enters the intake perforations at the side capture zones at a higher velocity (small blue arrows).

- A combination of inflow and downflow air streams forms an air barrier that prevents contaminated room air from entering the work zone, and prevents work surface emissions from escaping the work zone. The downflow combined with the inflow air enters the common air plenum.
- All air in the common plenum is HEPA-filtered and exhausted via a dedicated ducting system to the external environment.
- Fail-safe system ensures that in case of exhaust failure, the cabinet's main fan automatically shuts down to ensure safety to the user.

Model LB2 Biological Safety Cabinet Engineering Drawing

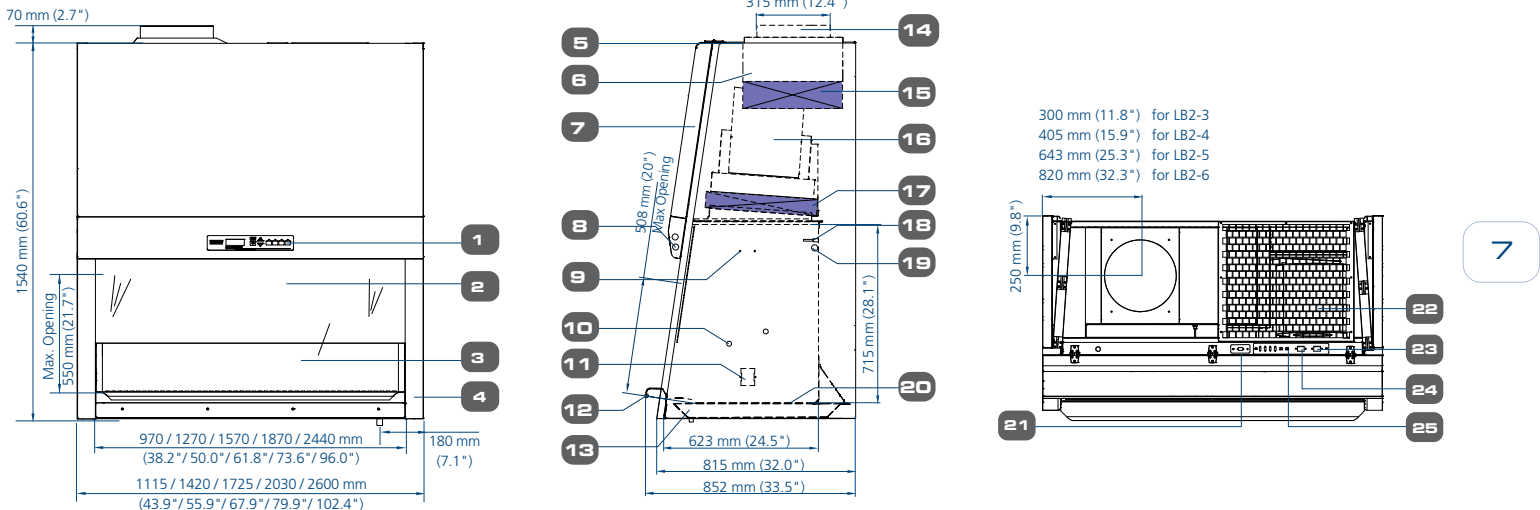

1. Sentinel™ Gold Microprocessor Controller
2. Tempered Glass Sash Window
3. Stainless Steel Back Wall
4. Side Panel
5. Pressure Switch Port
6. Exhaust Sensor
7. Electrical Panel
8. Fluorescent Lamp
9. IV Bar Retrofit Kit Provision
10. Service Fixture Retrofit Kit Provision
11. Electrical Outlet
12. Arm Rest
13. Drain Valve
14. Exhaust Ducting
15. Exhaust H14 Filter
16. Energy-efficient DC ECM Blower
17. Downflow H14 Filter
18. Downflow Sensor
19. UV Light Retrofit Kit Provision
20. Single Piece Stainless Steel Work Tray
21. RS232 Port
22. Pre-filter
23. Cabinet Power Inlet
24. Zero Voltage Relay Contact for Exhaust System
25. Zero Voltage Relay Contact for Remote Alarm

Recommended LB2 Cabinet Installation

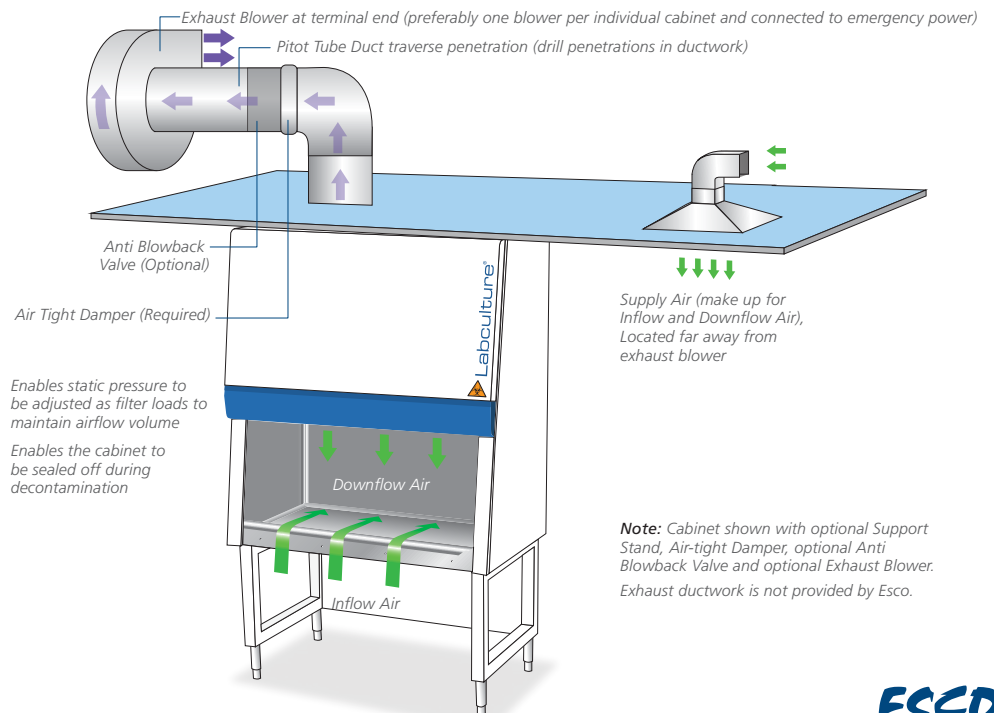

Accessories for LA2, LB2 and LR2 Biological Safety Cabinets

Cabinet	Stainless Steel Side Wall		LA2-3A1-E 2010705	LA2-4A1-E 2010670	LA2-5A1-E 2010671	LA2-6A1-E 2010672	LA2-8A1-E 2010928
			LA2-3A2-E 2010706	LA2-4A2-E 2010691	LA2-5A2-E 2010692	LA2-6A2-E 2010693	LA2-8A2-E 2011205
			LA2-3A3-E 2010707	LA2-4A3-E 2010685	LA2-5A3-E 2010686	LA2-6A3-E 2010687	LA2-8A3-E 2010921
			LB2-3B1-E 2010708	LB2-4B1-E 2010673	LB2-5B1-E 2010674	LB2-6B1-E 2010682	
			LB2-3B2-E 2010709	LB2-4B2-E 2010694	LB2-5B2-E 2010695	LB2-6B2-E 2010696	
			LB2-3B3-E 2010710	LB2-4B3-E 2010688	LB2-5B3-E 2010689	LB2-6B3-E 2010690	
				LR2-4S1-E 2010845	LR2-5S1-E 2010847	LR2-6S1-E 2010849	
			LR2-3S2-E 2010701	LR2-4S2-E 2010702	LR2-5S2-E 2010703	LR2-6S2-E 2010704	LR2-8S2-E 2011006
			LR2-3S3-E 2010913	LR2-4S3-E 2010851	LR2-5S3-E 2010853	LR2-6S3-E 2010855	
Exhaust Ducting	Anti-blowback Valve 10 inches (LA2 & LR2 only)	EG Powder Coated	ABBV-10P 5170352				
		304 Stainless Steel	ABBV-10S 5170354				
	Anti-blowback Valve 12 inches (LB2 only)	EG Powder Coated	ABBV-12P 5170353				
		304 Stainless Steel	ABBV-12S 5170355				
	Exhaust Damper		B2-DAMPER 5170104				
	Exhaust Collar (LA2 & LR2 only)		ECO-LA23-MK3-LH 5170097	ECO-LA24-MK3-LH 5170099	ECO-LA25-MK3-LH 5170101	ECO-LA26-MK3-LH 5170102	ECO-LA28-MK3-LH 5170536
	Inlet Collar (LB2 only)		ICO-LB23 5170320	ICO-LB24 5170263	ICO-LB25 5170316	ICO-LB26 5170322	
	Pre-filter (LB2 only)		PF-2 6090001				
UV Lamp		UV-15A-L 5170251	UV-30A-L 5170255			UV-15A-L (x2) 5170251	
IV Bar		IV-955 5170276	IV-1260 5170277	IV-1265 5170278	IV-1870 5170279		

8



ABBV_



B2-DAMPER



ECO-L_2_-MK3-LH



ICO-LB2_



UV_-A-L



IV_-



EO-H



EO-GFCI



SF-1_

Labculture® | Labculture® •RELIANT

LA2 & LR2 Class II Type A2 / LB2 Class II Type B2 Biological Safety Cabinets

Electrical Outlet	Direct Mounted / GFCI	EO_				
Service Fixtures	EU SF-Gas-40 mm	SF-1G40 5170002				
	EU SF-Vacuum-40 mm	SF-1V40 5170003				
	EU SF-Air-40 mm	SF-1A40 5170006				
	EU SF-Nitrogen-40 mm	SF-1N40 51700011				
	EU SF-Water-40 mm	SF-1W40 51700017				
	EU SF-Universal-40 mm	SF-2U40 51700018				
Support Stands, Ships Flat	Fixed Stand with Leveling Feet, 28" height	SPL-3A0 Gen 2 5130188	SPL-4A0 Gen 2 5130189	SPL-5A0 Gen 2 5130190	SPL-6A0 Gen 2 5130163	SPBL-8A0 5131286
	Fixed Stand with Leveling Feet, 34" height	SPL-3B0 Gen 2 5131092	SPL-4B0 Gen 2 5130151	SPL-5B0 Gen 2 5131093	SPL-6B0 Gen 2 5131094	SPBL-8B0 5131287
	Fixed Stand with Caster Wheels, 28" height	SPC-3A0 Gen 2 5130155	SPC-4A0 Gen 2 5130152	SPC-5A0 Gen 2 5130162	SPC-6A0 Gen 2 5130154	SPC-8A0 Gen 2 5131122
	Fixed Stand with Caster Wheels, 34" height	SPC-3B0 Gen 2 5130165	SPC-4B0 Gen 2 5130166	SPC-5B0 Gen 2 5130167	SPC-6B0 Gen 2 5130168	SPC-8B0 Gen 2 5131123
	Telescopic Stand with Leveling Feet, 1" adjustment	STL-3A0 5130050	STL-4A0 5130051	STL-5A0 5130052	STL-6A0 5130053	STL-8A0 5130054
	Telescopic Stand with Caster Wheels, 1" adjustment	STC-3A0 5130055	STC-4A0 5130056	STC-5A0 5130057	STC-6A0 5130058	STC-8A0 5130059
	Motorized Height Stand with Caster Wheels, 39.5" height	SPM-3A_	SPM-4A_	SPM-5A_	SPM-6A_	SPM-8A_
Misc	Arm Rest Padding	MEWREST 5170127				
	Foot Rest	FT-REST 5170492				
	Laboratory Chair	ME-LD-AR360 1150006				
	IQ OQ Protocol	9010179				



SF-2U_



SAL_A0 Gen 2



SAL_B0 Gen 2



SPC_A0 Gen 2



SPC_B0 Gen 2



STL_A0



STC_A0



SPM_A_



IQ OQ

Class II Type A2 Biological Safety Cabinets

TECHNICAL SPECIFICATIONS						
Labculture® Class II A2	LA2-3A_-E	LA2-4A_-E	LA2-5A_-E	LA2-6A_-E	LA2-8A_-E	
Labculture® Reliant Class II A2	LR2-3S_-E	LR2-4S_-E	LR2-5S_-E	LR2-6S_-E	LR2-8S_-E	
Nominal Size	0.9 meter (3')	1.2 meter (4')	1.5 meter (5')	1.8 meter (6')	2.4 meters (8')	
External Dimensions * (W x D x H)	1115 x 852 x 1540 mm (44.0" x 33.5" x 60.6")	1420 x 852 x 1540 mm (56.0" x 33.5" x 60.6")	1725 x 852 x 1540 mm (68.0" x 33.5" x 60.6")	2030 x 852 x 1540 mm (80.0" x 33.5" x 60.6")	2600 x 852 x 1540 mm (102.4" x 33.5" x 60.6")	
Internal Dimensions (W x D x H)	970 x 623 x 670 mm (38.2" x 24.5" x 26.4")	1270 x 623 x 670 mm (50.0" x 24.5" x 26.4")	1570 x 623 x 670 mm (61.8" x 24.5" x 26.4")	1870 x 623 x 670 mm (73.6" x 24.5" x 26.4")	2440 x 623 x 670 mm (96.0" x 24.5" x 26.4")	
Usable Work Area	0.45 m ² (4.8 sq.ft.)	0.6 m ² (6.5 sq.ft.)	0.75 m ² (8.1 sq.ft.)	0.9 m ² (9.7 sq.ft.)	1.2 m ² (13 sq.ft.)	
Tested Opening	229 mm (9")	229 mm (9")	229 mm (9")	203 mm (8")	203 mm (8")	
Working Opening	274 mm (10.8")	274 mm (10.8")	274 mm (10.8")	248 mm (9.8")	248 mm (9.8")	
Average Airflow Velocity	Inflow	0.53 m/s (105 fpm)				
	Downflow	0.35 m/s (70 fpm)	0.35 m/s (70 fpm)	0.35 m/s (70 fpm)	0.33 m/s (65 fpm)	0.33 m/s (65 fpm)
Airflow Volume	Inflow	424 m ³ /h (251 cfm)	555 m ³ /h (328 cfm)	686 m ³ /h (406 cfm)	724 m ³ /h (426 cfm)	945 m ³ /h (560 cfm)
	Downflow	628 m ³ /h (363 cfm)	822 m ³ /h (476 cfm)	1016 m ³ /h (588 cfm)	1210 m ³ /h (700 cfm)	1579 m ³ /h (914 cfm)
	Exhaust	424 m ³ /h (251 cfm)	555 m ³ /h (328 cfm)	686 m ³ /h (406 cfm)	724 m ³ /h (426 cfm)	945 m ³ /h (560 cfm)
	Required Exhaust with Optional Thimble Exhaust Collar	529 m ³ /h (311 cfm)	764 m ³ /h (450 cfm)	1116 m ³ /h (657 cfm)	1164 m ³ /h (685 cfm)	1540 m ³ /h (913 cfm)
	Static Pressure for Optional Thimble Exhaust Collar	32 Pa / 0.12 in H ₂ O	49 Pa / 0.19 in H ₂ O	62 Pa / 0.24 in H ₂ O	79 Pa / 0.31 in H ₂ O	100 Pa / 0.40 in H ₂ O
ULPA Filter Typical Efficiency	>99.999% for particle size between 0.1 to 0.3 microns per IEST-RP-CC001.3 / H14 per EN 1822					
Sound Emission**	NSF / ANSI 49	62.5 dBA	63 dBA	63.5 dBA	64 dBA	64.5 dBA
	EN 12469	59.5 dBA	60 dBA	60.5 dBA	61 dBA	61.5 dBA
Fluorescent Lamp Intensity	>1000lux (>93 foot-candles)					
Cabinet Construction	Main Body	Electro-galvanized steel with white oven-baked epoxy-polyester Isocide™ antimicrobial powder-coated finish, 1.5 mm (0.06") / 16 gauge thick				
	Work Zone	Stainless steel Type 304 with No.4 finish, 1.5 mm (0.06") / 16 gauge thick				
Electrical	Full Load Amps 230 V	10 A				10 A and 5 A
	Full Load Amps 115 V	13 A				13 A and 8 A
	Heat Load	853 BTU/Hr	972 BTU/Hr	1177 BTU/Hr	1297 BTU/Hr	1774 BTU/Hr
Nominal Power Consumption	250 W	285 W	345 W	380 W	520 W	
Net Weight***	243 Kg (536 lbs)	283 Kg (624 lbs)	350 Kg (772 lbs)	426 Kg (939 lbs)	580 Kg (1279 lbs)	
Shipping Weight***	292 Kg (644 lbs)	345 Kg (761 lbs)	410 Kg (904 lbs)	486 Kg (1072 lbs)	640 Kg (1411 lbs)	
Shipping Dimensions, Maximum (W x D x H)***	1200 x 950 x 1900 mm (47.2" x 37.4" x 74.8")	1550 x 950 x 1900 mm (61.0" x 37.4" x 74.8")	1950 x 950 x 1900 mm (76.8" x 37.4" x 74.8")	2150 x 950 x 1900 mm (84.6" x 37.4" x 74.8")	2720 x 950 x 1900mm (84.6" x 37.4" x 74.8")	
Shipping Volume, Maximum***	2.17 m ³ (77 cu.ft.)	2.80 m ³ (99 cu.ft.)	3.52 m ³ (124 cu.ft.)	3.88 m ³ (137 cu.ft.)	4.91 m ³ (173 cu.ft.)	

*Depth includes the remove-able arm rest and front cover.

When they are removed, depth is 790 mm (31.1").

Noise reading in open field condition / anechoic chamber. Noise reading in **normal room varies by room size, layout, and background noise, but may reach roughly 3-4 dBA above these values

***Cabinet only, excludes optional stand.

Class II Type A2 can be used to handle **minute** quantities of volatile toxic chemicals and **trace** amounts of radionuclotides when **thimble** ducted. Use this option if chemical vapor **re-circulation** into the work zone is permitted.

Power Rating	Voltage (VAC)	Frequency (Hz)	Example
1	230	50	LA2-4A1
2	115	60	LA2-4A2
3	230	60	LA2-4A3

Class II Type B2 Biological Safety Cabinets

TECHNICAL SPECIFICATIONS					
Labculture® Class II B2		LB2-3B_E	LB2-4B_E	LB2-5B_E	LB2-6B_E
Nominal Size		0.9 meter (3')	1.2 meter (4')	1.5 meter (5')	1.8 meter (6')
External Dimension* (W x D x H)	Without Base Stand	1115 x 852 x 1610 mm (44.0" x 33.5" x 63.3")	1420 x 852 x 1610 mm (56.0" x 33.5" x 63.3")	1725 x 852 x 1610 mm (68.0" x 33.5" x 63.3")	2030 x 852 x 1610 mm (80.0" x 33.5" x 63.3")
	With Optional Base Stand, 711 mm (28") type	1115 x 852 x 2321 mm (44.0" x 33.5" x 91.4")	1420 x 852 x 2321 mm (56.0" x 33.5" x 91.4")	1725 x 852 x 2321 mm (68.0" x 33.5" x 91.4")	2030 x 852 x 2321 mm (80.0" x 33.5" x 91.4")
Internal Dimensions (W x D x H)		970 x 623 x 715 mm (38.2" x 24.5" x 28.1")	1270 x 623 x 715 mm (50.0" x 24.5" x 28.1")	1570 x 623 x 715 mm (61.8" x 24.5" x 28.1")	1870 x 623 x 715 mm (73.6" x 24.5" x 28.1")
Usable Work Area		0.45 m ² (4.8 sq.ft.)	0.6 m ² (6.5 sq.ft.)	0.75 m ² (8.1 sq.ft.)	0.9 m ² (9.7 sq.ft.)
Tested Opening		203 mm (8.0")	203 mm (8.0")	203 mm (8.0")	203 mm (8.0")
Working Opening		274 mm (10.8")	274 mm (10.8")	274 mm (10.8")	248 mm (9.8")
Average Airflow Velocity	Inflow	0.53 m/s (105 fpm)			
	Downflow	0.31 m/s (60 fpm)			
Airflow Volume	Inflow	376 m ³ /h (223 cfm)	492 m ³ /h (292 cfm)	608 m ³ /h (361 cfm)	724 m ³ /h (429 cfm)
	Downflow	628 m ³ /h (363 cfm)	822 m ³ /h (476 cfm)	1016 m ³ /h (588 cfm)	1210 m ³ /h (700 cfm)
	CBV Exhaust Air Volume**	1127 m ³ /h (658 cfm)	1476 m ³ /h (862 cfm)	1824 m ³ /h (1065 cfm)	2173 m ³ /h (1269 cfm)
	Min Exhaust Static Pressure	400 Pa / 1.6 in H ₂ O	375 Pa / 1.5 in H ₂ O	375 Pa / 1.5 in H ₂ O	400 Pa / 1.6 in H ₂ O
	CBV Exhaust Static Pressure**	575 Pa / 2.3 in H ₂ O	550 Pa / 2.2 in H ₂ O	550 Pa / 2.2 in H ₂ O	575 Pa / 2.3 in H ₂ O
Supply ULPA Filter Typical Efficiency		≥99.999% for particle size between 0.1 to 0.3 microns			
Exhaust HEPA Filter Typical Efficiency		≥99.99% at 0.3 microns			
Maximum Sash Opening		508 mm (20")			
Sound Emission***	NSF / ANSI 49	57 dBA	58 dBA	59 dBA	60 dBA
	EN 12469	54 dBA	55 dBA	56 dBA	57 dBA
Fluorescent Lamp Intensity At Zero Ambient		>1000lux (>93 foot-candles)			
Cabinet Construction	Main Body	Electro-galvanized steel with white oven-baked epoxy-polyester Isocide™ antimicrobial powder-coated finish, 1.5 mm (0.06") / 16 gauge thick			
	Work Zone	Stainless steel Type 304 with No.4 finish, 1.5 mm (0.06") / 16 gauge thick			
Electrical	Full Load Amps 230 V	8 A			
	Full Load Amps 115 V	10 A			
	Heat Load	566 BTU/Hr	645 BTU/Hr	781 BTU/Hr	860 BTU/Hr
Nominal Power Consumption		166 W	189 W	229 W	252 W
Net Weight****		279 Kg (615 lbs)	317 Kg (699 lbs)	359 Kg (791 lbs)	438 Kg (966 lbs)
Shipping Weight****		318 Kg (703 lbs)	370 Kg (814 lbs)	402 Kg (886 lbs)	491 Kg (1083 lbs)
Shipping Dimensions, Maximum (W x D x H)****		1210 x 950 x 1950 mm (47.6" x 37.4" x 76.8")	1520 x 950 x 1950 mm (59.8" x 37.4" x 76.8")	1900 x 950 x 1950 mm (74.8" x 37.4" x 76.8")	2150 x 950 x 1950 mm (84.7" x 37.4" x 76.8")
Shipping Volume, Maximum****		2.24 m ³ (79.1 cu.ft.)	2.82 m ³ (99.6 cu.ft.)	3.52 m ³ (124.3 cu.ft.)	3.98 m ³ (140.6 cu.ft.)

*Height includes exhaust collar, and depth includes the remove-able arm rest and front cover. When they are removed, depth is 790 mm (31.1").

**This Concurrent Balance Value (CBV) Exhaust Volume (per Pitot Duct Traverse) and Static Pressure at cabinet exhaust connection should be used when sizing the HVAC exhaust and supply.

***Noise reading in open field condition / **anechoic** chamber. Noise reading in **normal room varies** by room size, layout, and background noise, but may reach roughly 3-4 dBA above these values

****Cabinet only, excludes optional stand.

Power Rating	Voltage (VAC)	Frequency (Hz)	Example
1	230	50	LB2-4B1
2	115	60	LB2-4B2
3	230	60	LB2-4B3

Class II Type B2 can be used to handle volatile toxic chemicals and radionucleotides because by default it's hard ducted. Use this option if chemical vapor **re-circulation** into the work zone is **not** permitted.

ESCO LIFESCIENCES GROUP

42 LOCATIONS IN 21 COUNTRIES ALL OVER THE WORLD

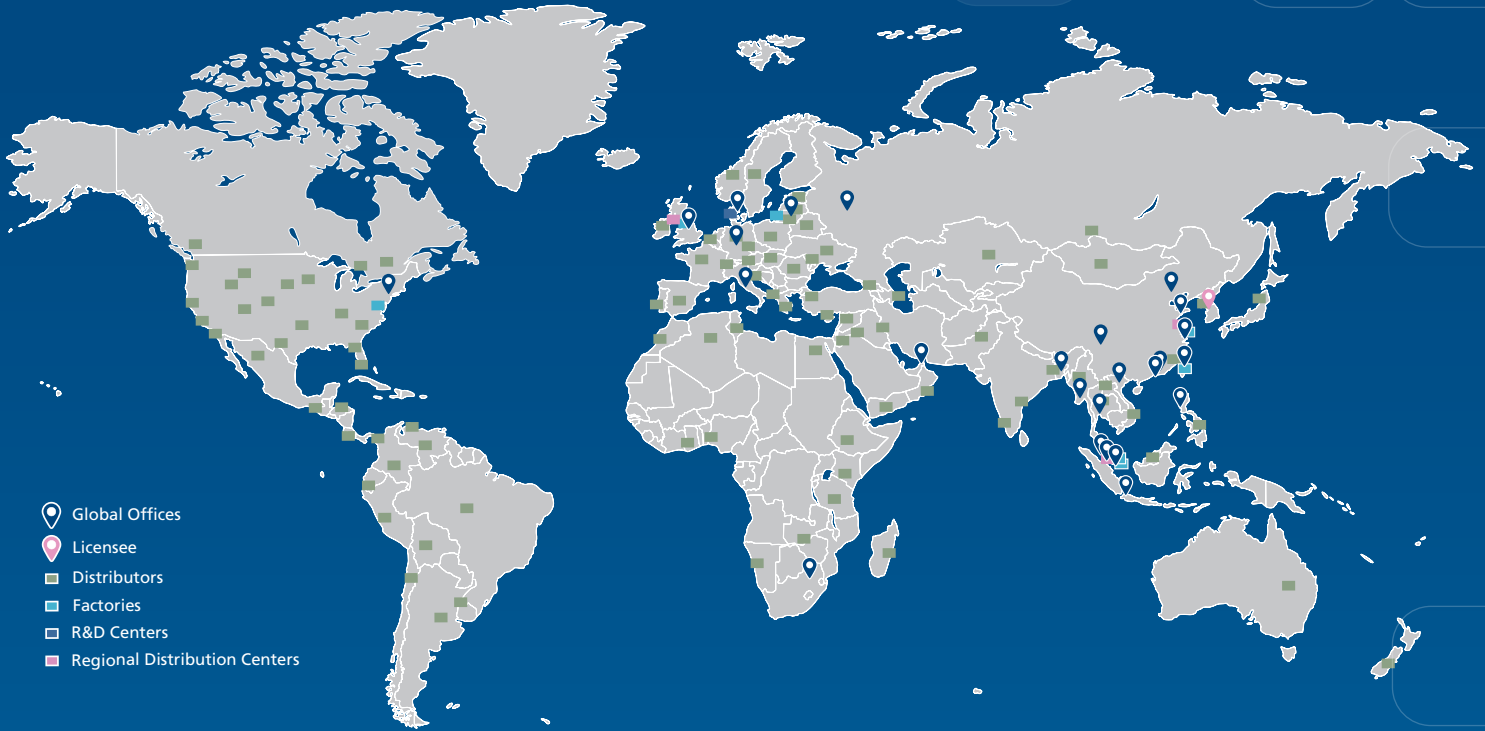

- Global Offices
- Licensee
- Distributors
- Factories
- R&D Centers
- Regional Distribution Centers

Follow us on social media, download our apps,
and scan the QR code for more info.



@Escolifesciences



@Escolifesciences



@Escolifesci



@Esco



@Escolifesciences



@Escolifesciences



Esco Lifesciences



Esco Lifesciences

ESCO

LIFESCIENCES GROUP

Esco Micro Pte. Ltd. • 21 Changi South Street 1 • Singapore 486 777
Tel +65 6542 0833 • mail@escolifesciences.com
www.escolifesciences.com

Esco Technologies, Inc. • 903 Sheehy Drive, Suite F, Horsham, PA 19044, USA
Tel: +1 215-441-9661 • Fax 484-698-7757
eti.admin@escolifesciences.com

Esco Lifesciences Group Offices: Bangladesh | China | Denmark | Germany | Hong Kong | India | Indonesia | Italy | Japan | Lithuania
| Malaysia | Myanmar | Philippines | Russia | Singapore | South Africa | South Korea | Taiwan | Thailand | UAE | UK | USA | Vietnam